

ROOF PLAN - DACH-PLAN - PLAN DU TOIT

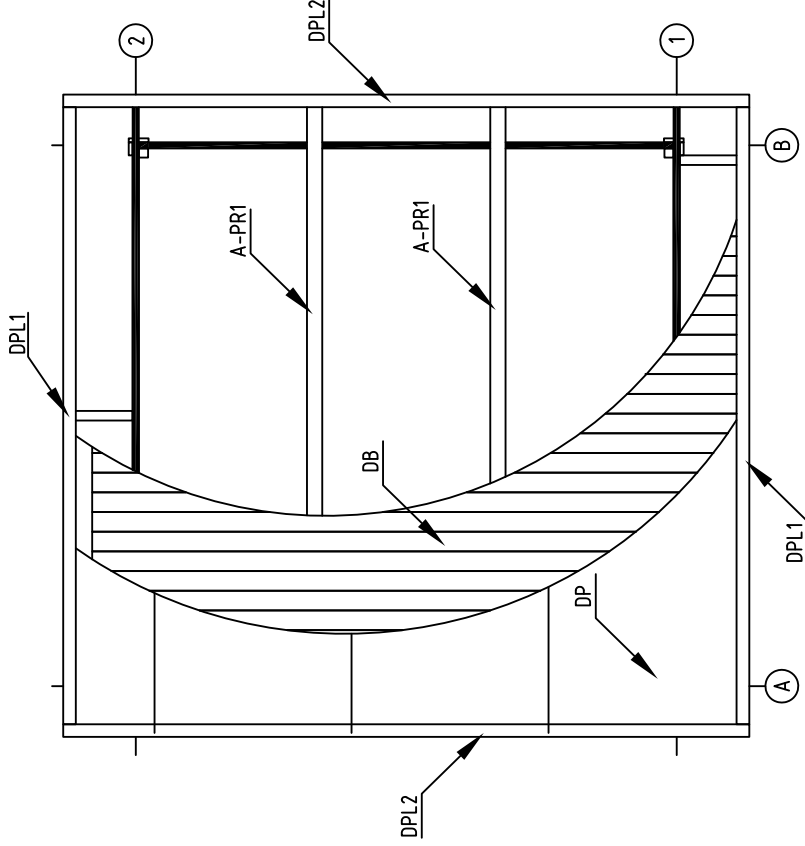

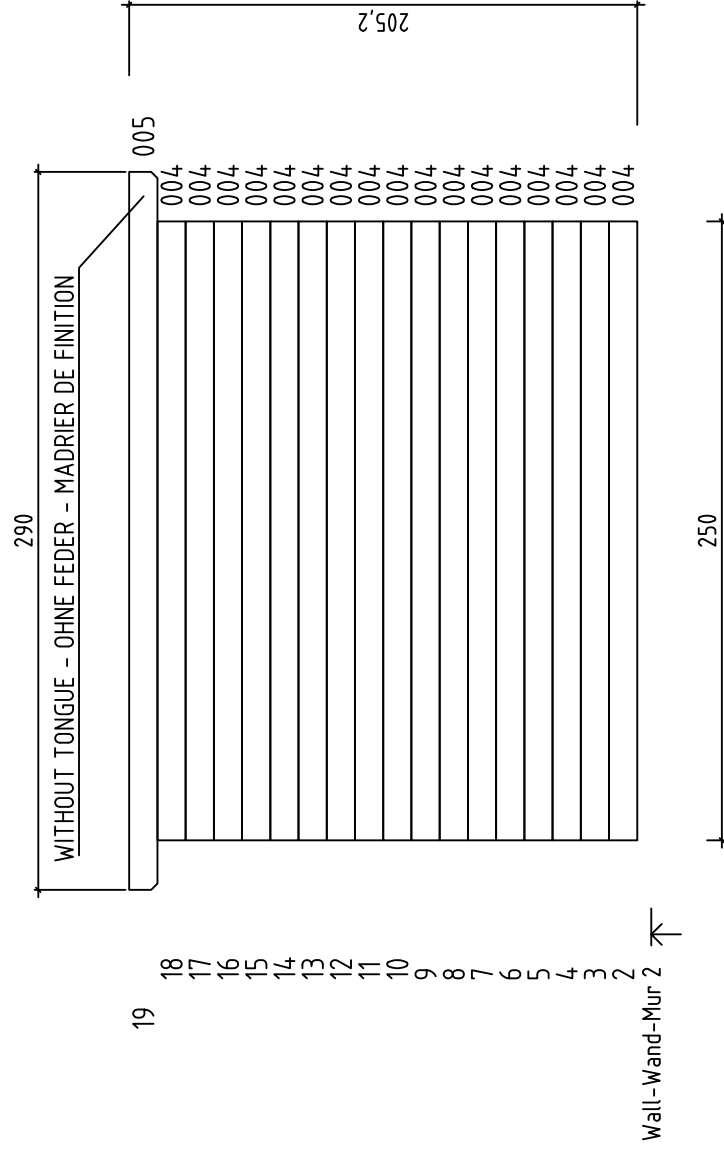

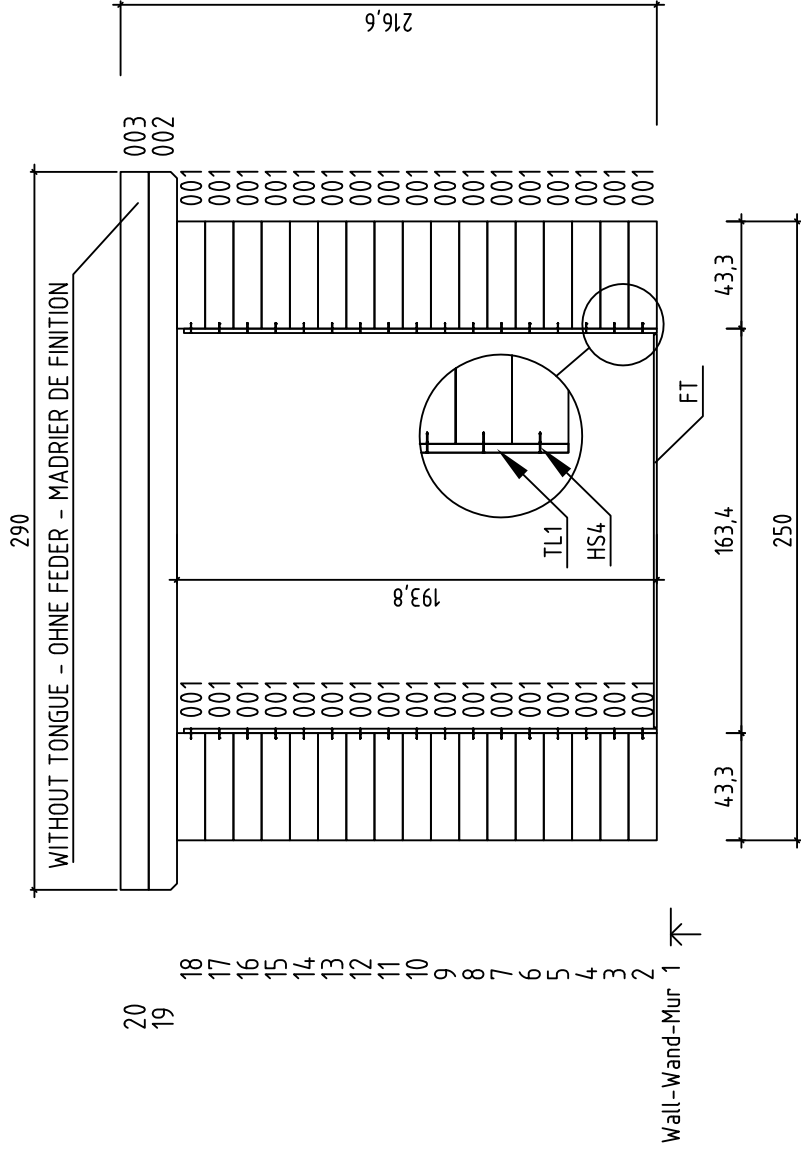

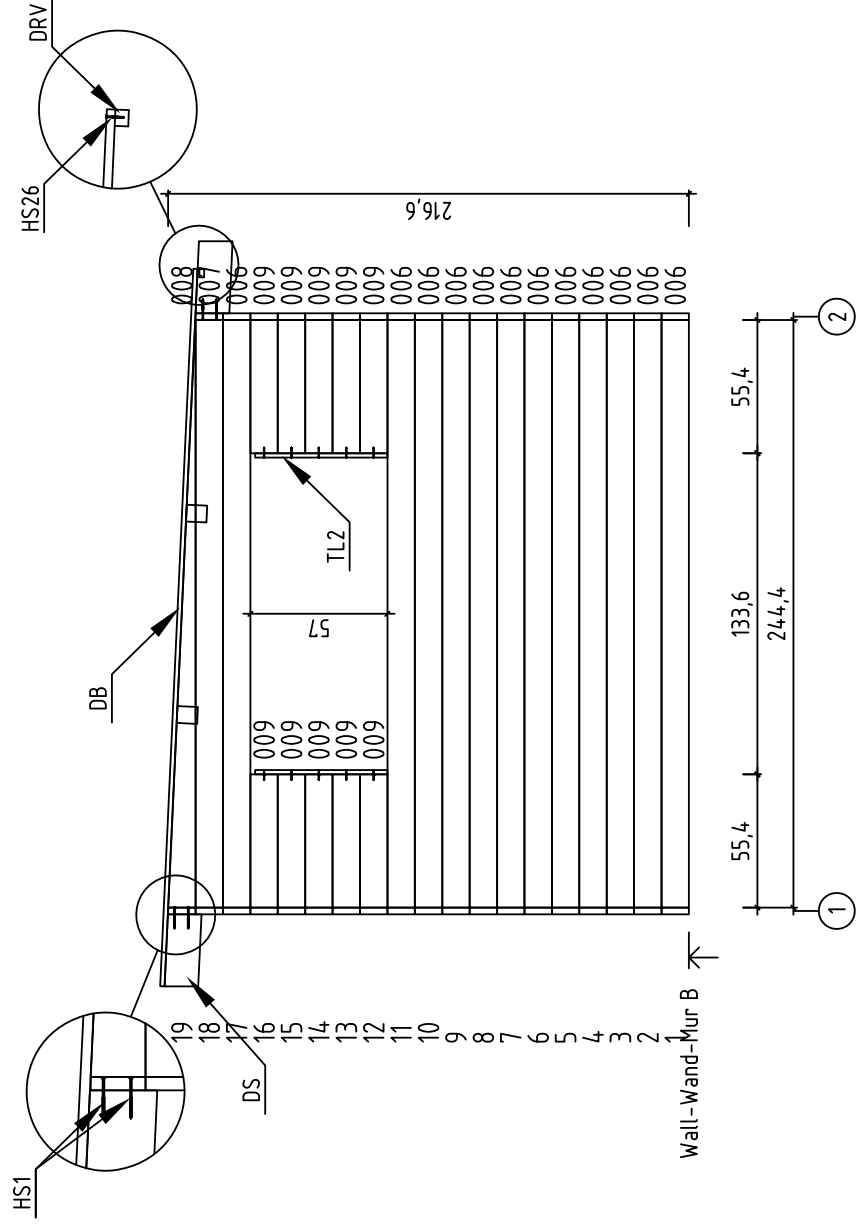
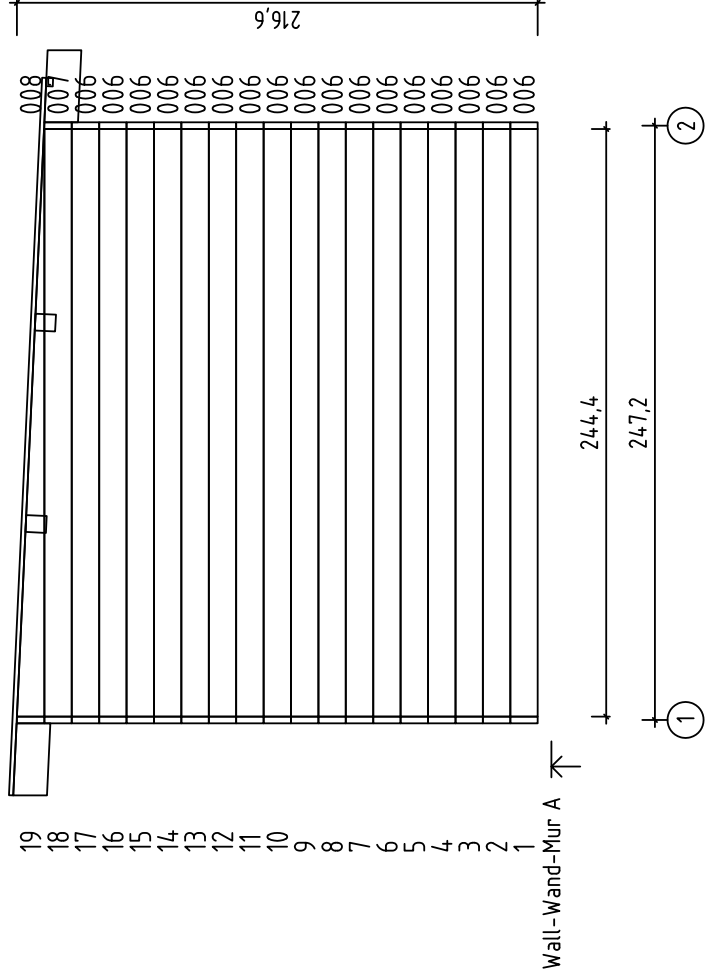

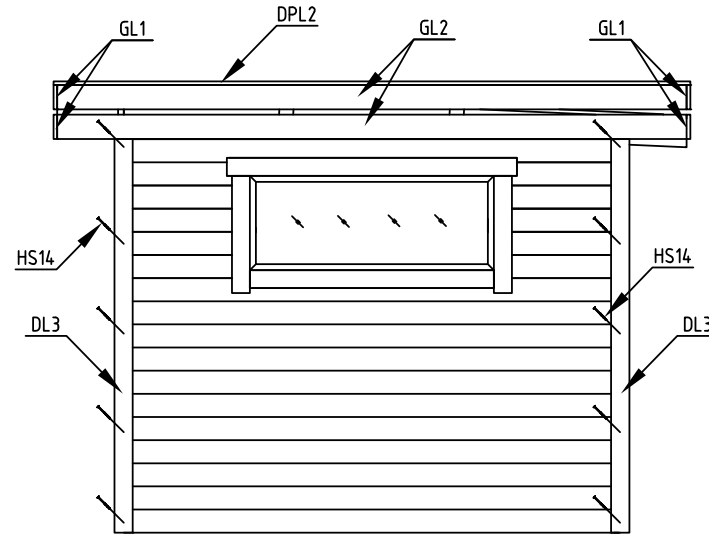
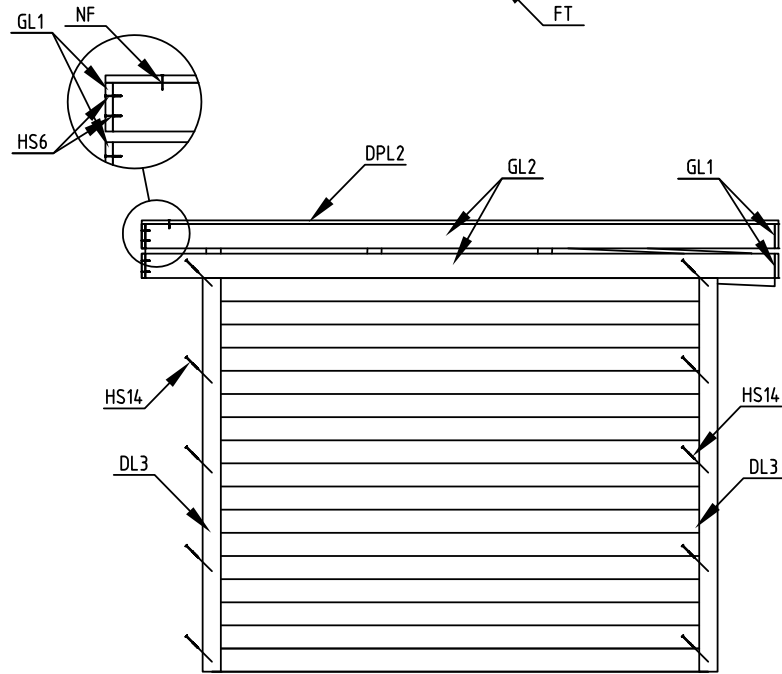
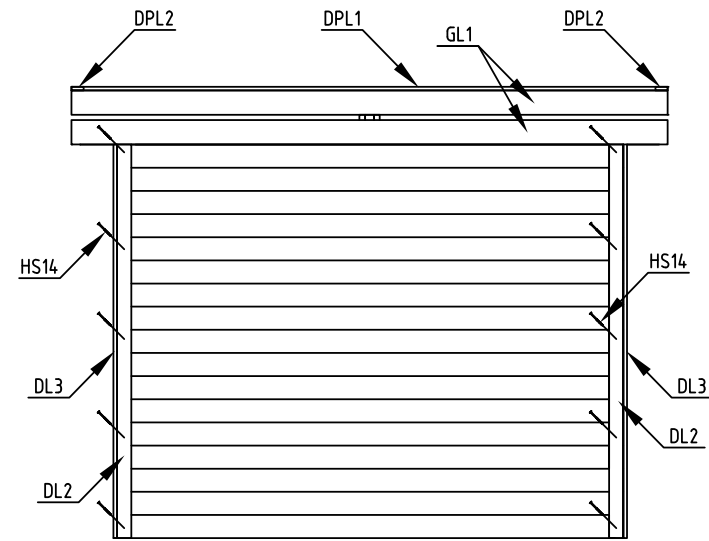
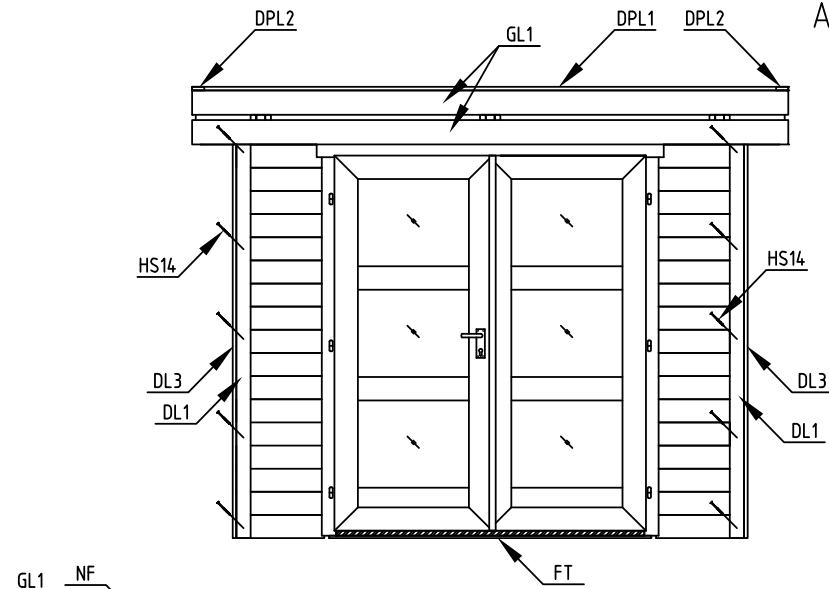







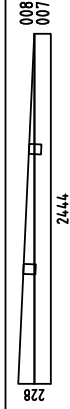

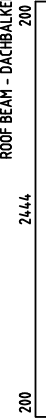



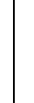
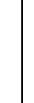





Art.Nr. 2813750



Pos	Piecelist - Stücklist - Liste des composants	Q.	P. (mm)	L. (mm)
001		34	28x114	433
002		1	28x114	2900
003		1	28x114	2900
004		17	28x114	2500
005		1	28x114	2900
006		29	28x114	2444
009		10	28x114	554
WA-1		1		
WB-1		1		
A-PR1		2	70x140	2900
DB	ROOF BOARDS - DACHBRETTER - VOLIGES 	33	90x18	2988
DPL1	ROOFING FELT FILLET - DACHPAPPENLEISTE - BAGUETTE DE FIXATION DU FEUTRE BITUMEUX 	2	18x58	2820
DPL2	ROOFING FELT FILLET - DACHPAPPENLEISTE - BAGUETTE DE FIXATION DU FEUTRE BITUMEUX 	2	18x58	3136
FT	FILLET UNDER DOORSTEP - LEISTE UNTER TÜRSWELLE - BANDE EN ARBRE PORTE 	1	12x22	1588
DL2	CEILING BATTEN - DECKLEISTE - PROFILS DE FINITION ANGLES A L'EXTERIEUR 	2	18x70	2052
DL1	CEILING BATTEN - DECKLEISTE - PROFILS DE FINITION ANGLES A L'EXTERIEUR 	2	18x70	2166
DL3	CEILING BATTEN - DECKLEISTE - PROFILS DE FINITION ANGLES A L'EXTERIEUR 	4	18x90	1938
EP2	CORNER STUD - ECKPFOSTEN - POTEAUX POUR PREAU 	2	42x42	1970
EP1	CORNER STUD - ECKPFOSTEN - POTEAUX POUR PREAU 	2	42x42	2085
DRV	ROOF EDGE REINFORCEMENT - DACHRANDVERSTÄRKUNG - CORNIERE DE RENFORT DE BORD DE TOIT 	2	28x34	1427
TL2	FINISHING STRIP FOR WINDOW - ABSCHUSSLEISTE FÜR FENSTER - MONTANT DE FINITION DES OUVERTURES FENETRES 	2	18x28	550
TL1	FINISHING STRIP FOR DOOR - ABSCHUSSLEISTE FÜR TÜR - MONTANT DE FINITION DES OUVERTURES PORTES 	2	18x28	1910
DP	ROOFING FELT - DACHPAPPE - FEUTRE BITUMEUX 	4		3000
BL	FIXING SLAT FOR DISTANCE SPACERS - BEFESTIGUNGSLEISTE - RENFORTS PLANCHES DE RIVES 	8	28x34	250
DS	DISTANCE SPACERS FOR GABLE MOULDING - DACHSTÜZEN - SUPPORTS EXTENSION TOITURE 	4	44x140	307

Pos	Piecelist - Stücklist - Liste des composants	Q.	P. (mm)	L. (mm)
GL1	GABLE MOULDING - GIEBELLEISTE - - PLANCHE DE RIVE	4	18x120	2936
GL2	GABLE MOULDING - GIEBELLEISTE - - PLANCHE DE RIVE	4	18x120	3100
HS3	SCREW FOR ROOF BEAMS - SCHRAUBEN FÜR DACHBALKEN - VIS POUR PANNE DE TOIT	4	5x120	
HS7	SCREW FOR CEILING BATTEN - SCHRAUBEN FÜR DECKLEISTEN - VIS DE FIXATION PROFILS DE FINITION ANGLES A L'EXTERIEUR	48	3.5x35	
HS4	SCREWS FOR FINISHING STRIP - SCHRAUBEN FÜR ABSCHUSSELEISTE VIS DE MONTANT DE FINITION DES OUVERTURES	44	4x40	
HS4	SCREW FOR DISTANCE SPACER FIXING SLAT - SCHRAUBEN FÜR BEFESTIGUNGS- LEISTE - VIS DE FIXATION RENFORTS PLANCHES DE RIVES	16	4x40	
HS2	SCREWS FOR WALL MOUNTING - SCHRAUBEN FÜR WANDMONTAGE - VIS DE FIXATION AU MUR	230	4x60	
HS1	SCREW FOR FIXING GABLE MOULDING DISTANCE SPACERS TO THE WALL SCHRAUBEN FÜR DACHSTÜZEN - VIS DE SUPPORTS EXTENSION TOITURE	8	5x90	
SH	HAMMER BLOCK - SCHLAGHOLZ - CALLE DE FRAPPE	1		
DS1	ZN NAIL FOR ROOF - ZN NÄGEL FÜR DACHBRETTNER - POINTE POUR TOIT	142	2x50	
DS2	ZN NAIL FOR ROOFING FELT FILLET - ZN NÄGEL FÜR DACHAPPENLEISTE - POINTE POUR BAGUETTE FIXATION FEUTRE BITUMEUX	28	2x40	
DS4	ROOFING NAILS FOR ROOFING FELT - NÄGEL FÜR DACHPAPPE POINTE DE FIXATION POUR FEUTRE BITUMEUX	126	2x17	
HS6	SCREW FOR GABLE MOULDING - SCHRAUBEN FÜR GIEBELLEISTE - VIS DE FIXATION POUR PLANCHE DE RIVE	64	3.5x50	
HS4	SCREW FOR ROOF EDGE REINFORCEMENT - SCHRAUBEN FÜR DACHRANDVERSTÄRKUNG - VIS POUR RENFORT DE BORD DE TOIT	8	4x40	
HS1	SCREW FOR DOOR JAMB - SCHRAUBE FÜR TÜRRAHMEN - - VIS DE FIXATION POUR MONTANT DE PORTE	4	5x90	
HS5	SCREW FOR DOOR FILLET - SCHRAUBE ZUR BEFESTIGUNG TÜRLEISTE - - VIS D'ASSEMBLAGE DU CADRE DE PORTE	5	3x30	
	SET OF DOOR LOCK COVERS - SCHLOSSBLENDEN - SET DE GARNITURES DE SERRURE DE PORTE	1		
HS8	SCREW FOR DOORSTEP - SCHRAUBEN FÜR SWELLE - VIS DE FIXATION DU SEUIL DE PORTE	3	4.5x65	
	MALE BOLT HINGE FOR DOOR - TÜRRIEGEL - PARTIE MALE DE CHARNIERE DE PORTE	6		
	DOOR HANDLE FITTINGS - TÜRGRIFF - SET DE GARNITURES DE SERRURE DE PORTE	1		
	CYLINDER LOCK - ZYLINDERSCHLOSS - CYLINDRE DE SERRURE	1		
	WINDOW - FENESTER - FENETRE 1290x540 SGC	1		

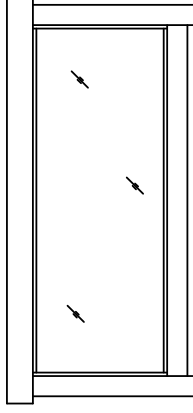

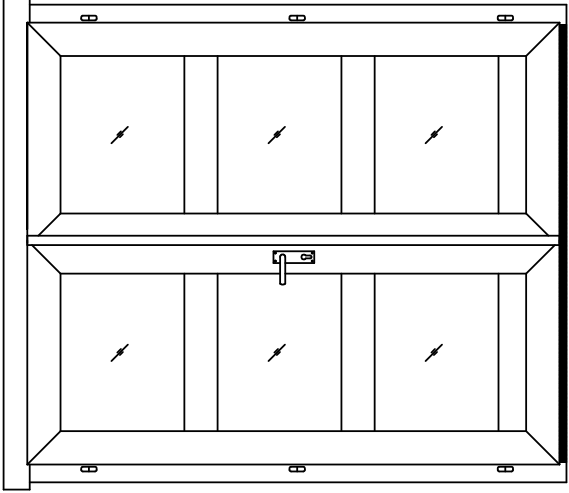
Pos	Piecelist - Stücklist - Liste des composants	Q.	P. (mm)	L. (mm)
	D00R - TÜR - PORTE 1588x1894 SGC  TUK.3.030.SVV.MMTb	1		